

## Smart Systems 'Visofold 1000' installation manual.

**IMPORTANT**  
Protective tape must  
be removed after  
installation.



**IMPORTANT**  
Do not use white  
spirit or any solvent  
based cleaners.

**IMPORTANT**  
Please read  
before installation

# Contents:

1. Outerframe assembly
2. Corner Preparation
3. Door Layout
4. Installing Outerframe
5.
  - a. Hinge Adjustment
  - b. Hinge Assemblies
6. Toe and Heeling & Glass Adjuster Kit
7. Installing Wedge Gasket
8. Gasket Detail
9.
  - (i) Low Threshold
  - (ii) Standard Threshold
10. Add-on and trickle vents

# 1. Outer frame assembly.

NOTE: PLEASE READ THESE INSTRUCTIONS BEFORE FITTING THE DOORS!



1.

As shown, select two cleats, and one chevron

2

Fill inside the chamber with glue provided and then place the two cleats and chevron, into top and bottom sections of the outer frame at both ends, placing the correct size cleat into both slots and ensuring the punch holes are aligned. Locate the two sides of outer frame onto the cleats. Before you completely close the joints add silicone (not provided) to all points of contact to provide weather protection. Joints can be difficult to close and gentle use of a rubber mallet may be required to create a tight joint.



3.

Once the joints of the outer frame have been closed and sealed. Fit fixing blocks as per drawing. Use allen key (usually 2,5mm but occasionally 3mm) to wind bolts in to make a nice tight joint. Ensure the joint is square by loosening one bolt and tightening the other. This will pull joint square. See next page.

**DO NOT RUSH THIS, IF THE JOINTS AREN'T SQUARE IT WILL AFFECT THE DOORS PERFORMANCE**

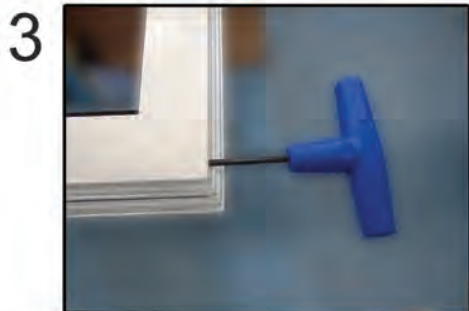

4

You must ensure the drainage slots are on the bottom section of the outer frame prior to fixing into opening.

5

*(Only if low threshold specified)*

Fit low threshold (DV173) using screws provided. Screws can be lubricated to make fitting easier. **Again, seal the joint with silicone before and after screwing together to provide weather protection. Ensure endcaps fit correctly and are sealed on. Even if delivered assembled it is also advisable to cover with silicone prior to installation to ensure a good seal.**

*When fitting a cill with this style of threshold you may be required to notch out an area for the rebate to fit into.*

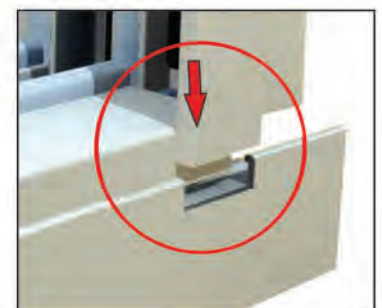

5

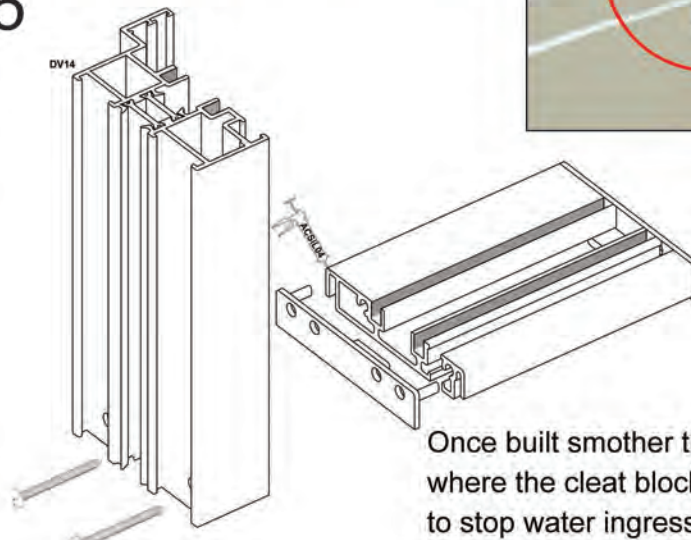

Once built smother the outerfaces where the cleat blocks fit with silicone to stop water ingress.

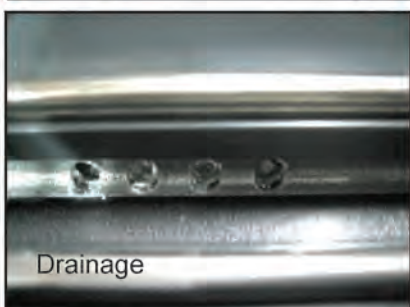

## 2. Corner Preparation

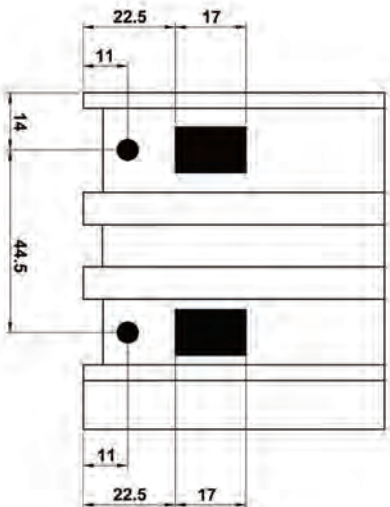

**Can adjust corner squareness by loosening/tightening. Ensure both are fully tightened on installation.**

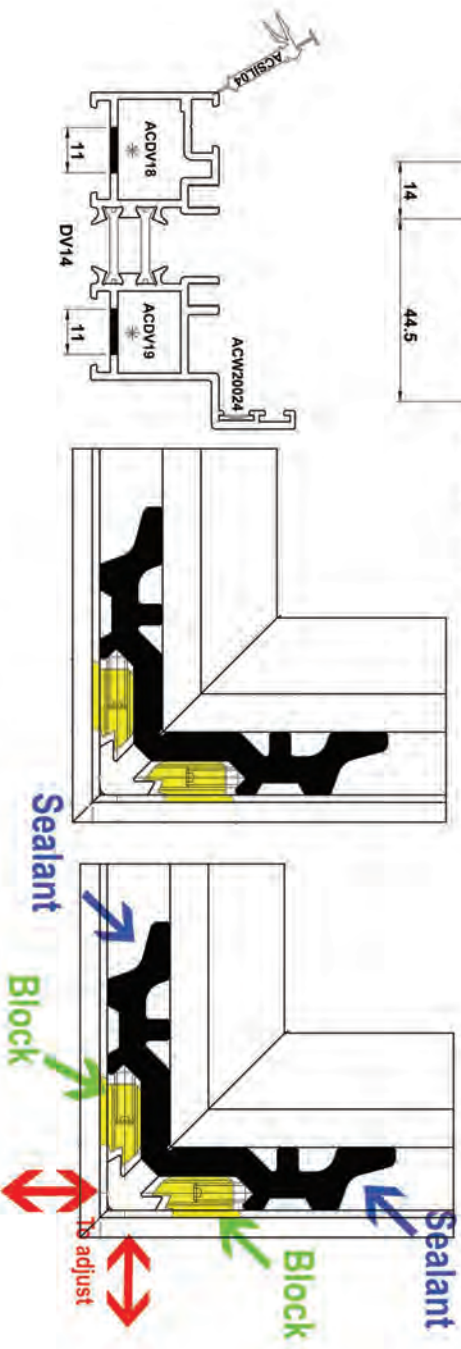

## 3. Door Layout

Your folding door style viewed from the outside is :

(When doors are supplied in kit form this will be completed by fabricator to suit individual door styles)

Mullions with wheels shown as a 'W'. Mullions with locking handles shown as 'H'.

Doors are numbered in the order they are to be fitted. See section two below for details.

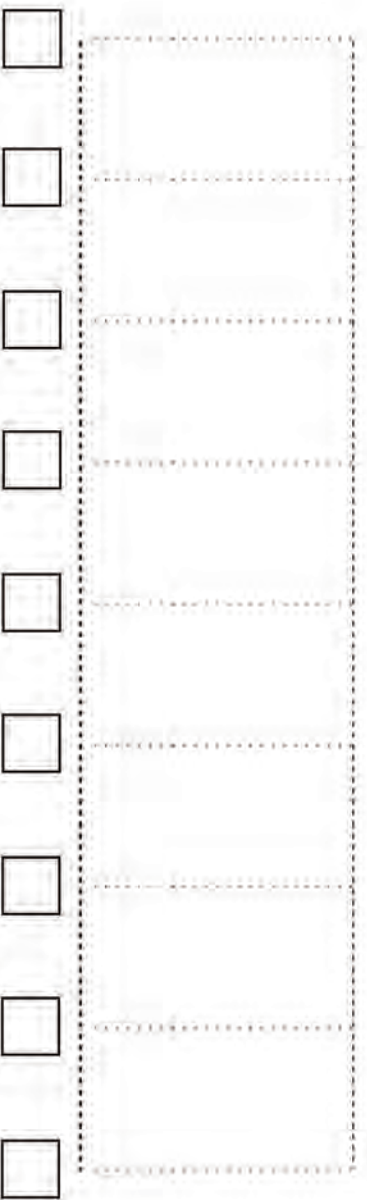

Your folding door style viewed from the above is :

**INSIDE**

**OUTSIDE**

## 4(i). Installing the Outerframe

Once the outer frame has been assembled the frame can be fitted into the opening. You may wish to fit the cill to the outer frame prior to offering the whole frame to the opening. Alternatively fit the cill to the opening first, ensuring it is level and flat and sit the frame on top. If the frame is under 4m you may wish to install the doors prior to fixing the frame, however if this is the case Affordable Windows will supply the door complete unless instructed otherwise at time of ordering. On large frames (4m+) we advise you fit the frame separately and fit the doors afterwards.

To ensure the doors function correctly when finished it is essential to ensure that the frame has been fitted level, square, plumb and with parallel sides. The frame must not be bowed out due to excessive force from fixings or the doors will not operate correctly. If this is the case packers must be used to keep all the sides parallel to each other. Once you are happy with the fixing of the outer frame we advise you check both diagonals are equal and that the width and height are correct all the way along each edge of the frame.

### Installation Checklist

Frame will fit in the opening with out distortion	<input type="checkbox"/>
Bottom of the frame fixed straight and level +/-2mm	<input type="checkbox"/>
Sides fixed plumb	<input type="checkbox"/>
Head fixed straight and level +/-2mm	<input type="checkbox"/>
Ensure outer frame is true and square	<input type="checkbox"/>
All sash toe and heeled square +/-2mm	<input type="checkbox"/>
Lock operation tested and working	<input type="checkbox"/>

ENSURING THE CORRECT FIT WILL MAKE SURE THE BIFOLD IS WEATHER TIGHT AND WILL OPERATE CORRECTLY.

**VERY IMPORTANT. PLEASE MAKE SURE YOU SPEND TIME MAKING THE OUTER FRAME LEVEL ,SQUARE AND PLUMB. THIS WILL SAVE YOU COUNTLESS HOURS TRYING TO ADJUST THE BIFOLD DOOR LATER.**

## 4(ii). Installing the Outerframe

Please note our Bi-Folding doors under 4m are normally supplied fully assembled and tested, over 4m are assembled and tested before being flatpacked, it is therefore imperative the following instructions are followed.

1. First check the frame will fit the opening without distortion.
2. On larger frames lift from the bottom of the frame to stop distortion when lifting.
3. Position the frame in the opening, pack the bottom first then the sides and finally the head, ensuring the frame is level and straight, **Check with a laser or spirit level to achieve this.**
4. (Linear tolerance allowed +/- 2mm all round. Tolerances front to back of the frame all around
5. +/- 0mm ) check the head has enough room to be fixed straight and level.
6. Fix bottom first, then the sides and the lastly the head of the frame.
7. Screw fixings 150mm from the edge of the frame, then 600mm centres using 150mm long fixing (100mm long minimum.)
8. Then fix the sides of the frame keeping tolerances linear +/- 2mm  
Fix the head of the frame level and straight, keeping tolerances linear +/- 2mm

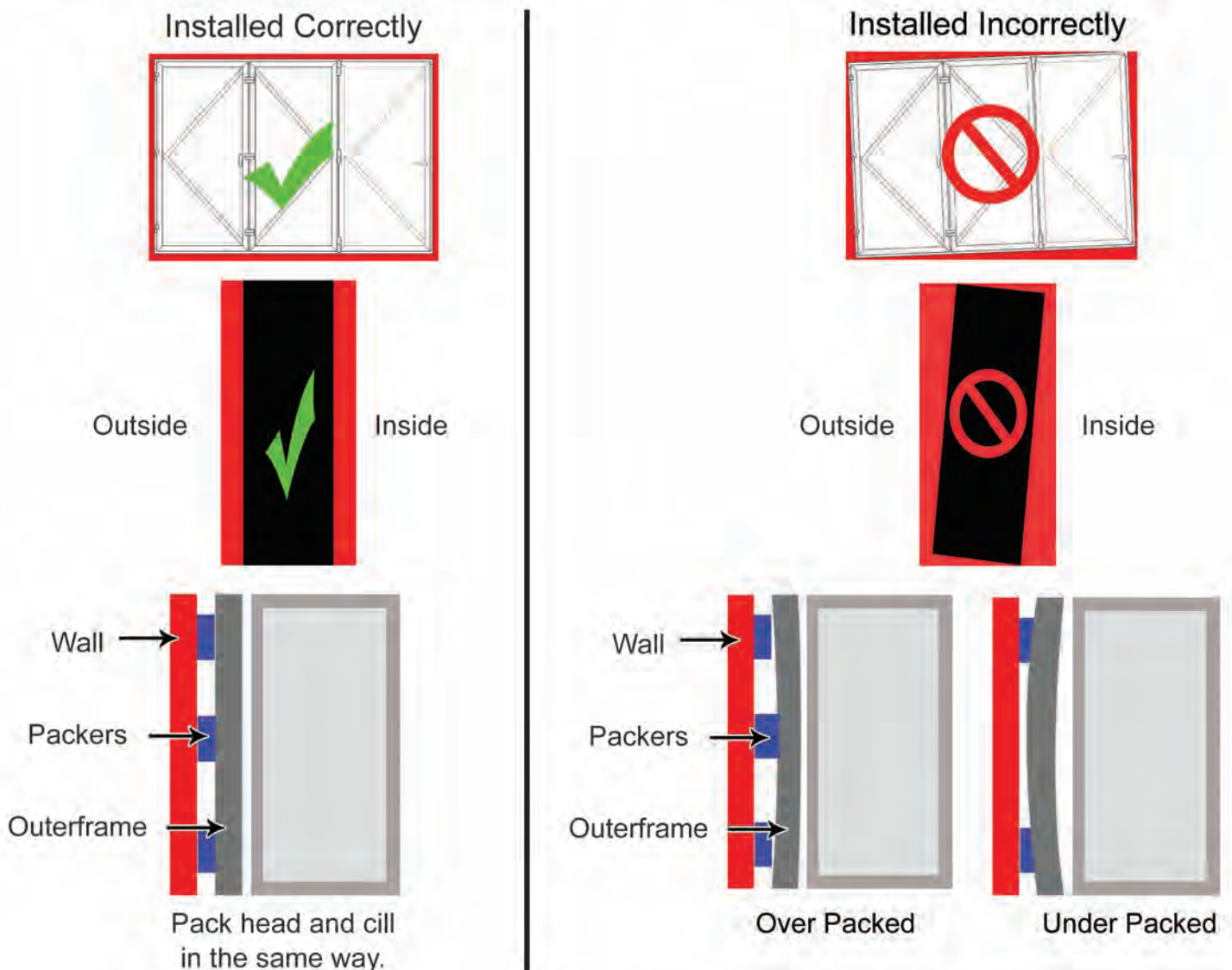

We advise that after packing and fixing frame you **DO NOT** foam or trim up.

This should be done after all the doors have been fitted, glazed and checked for operation. By doing this it will give you the option of moving the frame around the doors should the need arise.

# 5a Hinge Adjustment



Whilst every effort is made to ensure your bifold is set up in the correct position, due to transportation and installation it may be necessary to adjust the height of the doors in the frame.

Should this be required it is a relatively simple process.

Simply open the doors and ensure they are fully supported. Loosen the screws (PIC 1) holding the hinges to the backing plates, **DO NOT** loosen too much as they will fall out as they are quite short (see PIC 4).



Next you will need a 2.5mm allen key. Looking at the hinges you will notice small holes which house the locking grub screws (PIC 2).

By loosening these you will be able to move the doors up and down as required. Care needs to be taken as the doors will be unstable and awkward once you loosen the hinges.

There should be enough flex in the gaskets to allow small adjustment of the hinge positions as these are cut slightly longer when manufactured.

After any adjustment made you must ensure everything is tightened up.



Final fixing screws **MUST** be installed correctly - failure to do so will eventually result in the bifold failing (PIC 3).



# 5b Hinge Assemblies



Doors should be fitted in the order they are numbered on the previous page. Each door will be numbered during manufacture prior to delivery.

**DO NOT** attempt to glaze the doors until they are firmly fixed in place

Where possible the doors will be supplied in pairs already hinged to each other with wheels and rollers attached.

To install, take your first pair of 'fixed doors' (usually numbered 1 & 2), and support them at the base and screw the hinge assembly to the plate that is in the frame (PIC 1).

The screws (PIC 1A) are provided in the box of fittings supplied. Make sure when tightening the screws you do not over torque them as you will strip the threads and the screw will simply spin.



Once fitted to the frame the bottom wheel (PIC 2) and top roller (PIC 3) fitted to the door will need locating. You may be able to do this by simply lifting in the doors at a very slight angle (too steep and too much force will damage the bi-fold), however it is preferable to remove one of the wheel/rollers to make this easier.

Once the doors and wheels are located (PIC 4 & 4A) check they are level, all screws are tight and the repeat procedure on the other doors.



Once the doors are fully glazed, ensuring toe and heeling is correct, check the operation, and all screws are fitted correctly. **YOU MUST FIT THE FINAL FIXING SCREWS - FAILURE TO DO SO WILL RESULT IN THE DOORS FALLING OUT CAUSING HARM/INJURY.**

Remember the bifolds have no adjustment. If you are having issues check the toe & heeling of the glass, the squareness of the corners you have assembled and the plumb/level of outerframe.





# 6. Toe & Heeling: see also 6b Glass Adjuster Kit

When glazing the doors they must be toe & heeled correctly to ensure the weight is loaded onto the correct points on the frame. The above diagram shows how packers must be placed in opposite corners, with the lower corner being where the weight is to be loaded to. The lower point will either be next to a rolling mullion, or against the outer frame if the door being glazed is hinged to the outer frame. The lower diagram shows the location of the rolling mullion and, in this case, how both outside doors are hinged on the outer frame. The packers in the corners need to be a tight fit but not excessively tight or the sash may be pushed out of square.

1 & 2 Panel  
Inside View

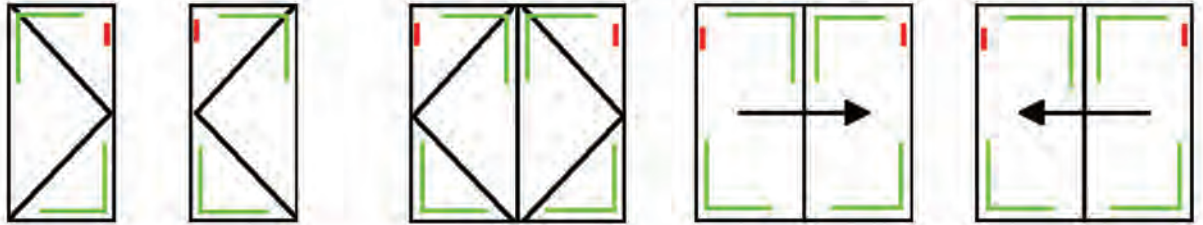

3 Panel Inside View

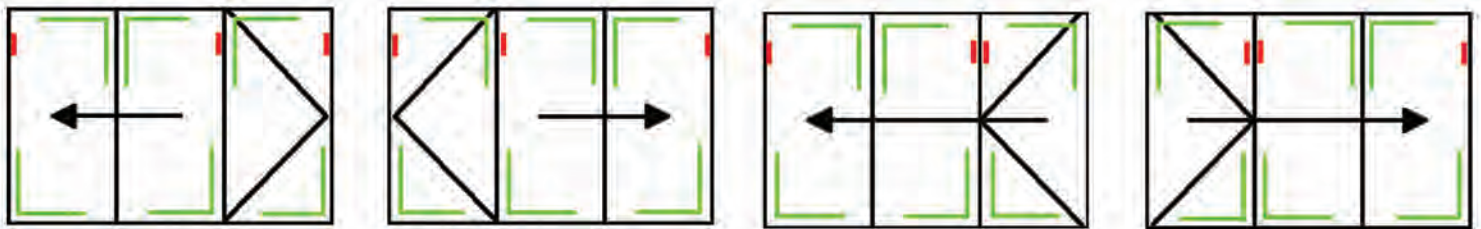

4 Panel  
Inside View

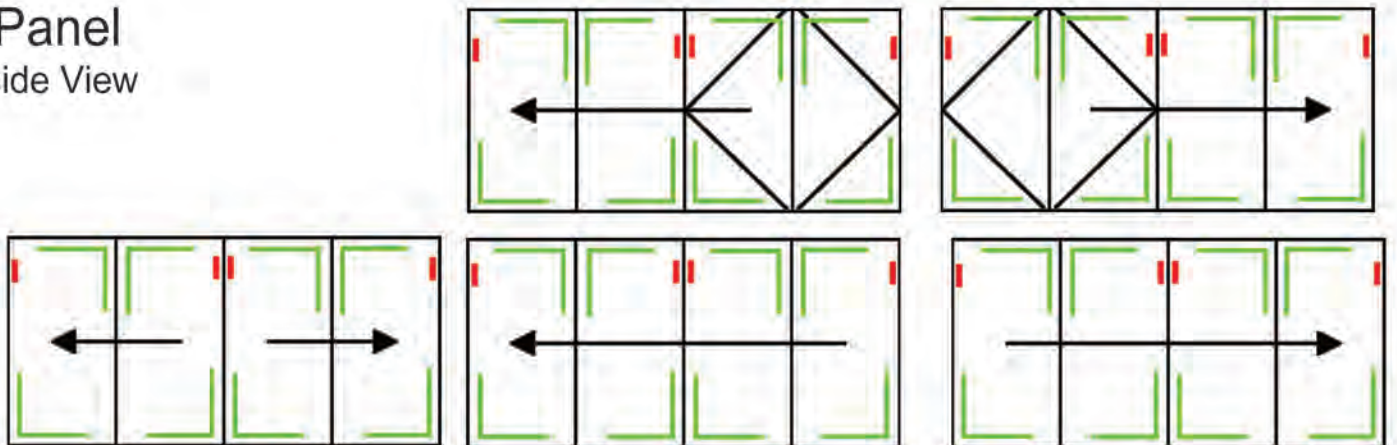

5 Panel  
Inside View

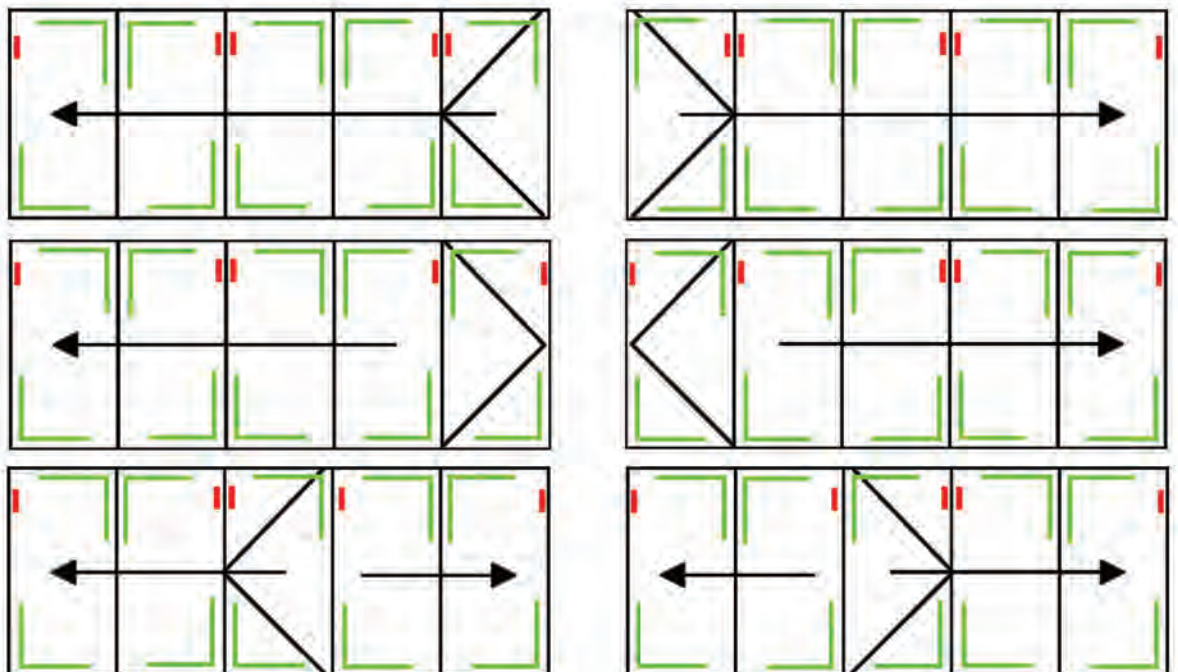

## 6b. Toe & Heeling: Glass Adjuster Kit

When door sashes reach a certain size a glass adjustment kit (ACDV295) will be fitted. This is purely an aid to toe and heeling to make it easier for the fitter.

The kit comprises of a fixed plate, adjuster bolt (both of which are pre-fitted), reinforcing plate and a L packer (these will be in the box).



The adjuster kit will be fitted to the top where toe and heeling packers would normally be used, see example 1 below

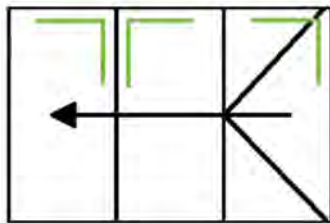

Example 1  
Position of  
glass adjuster kit

To make use of the kit, pack the bottom corners as you normally would, ensuring enough clearance for adjustment

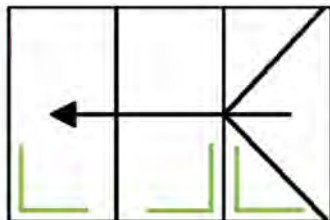

Example 2  
Position of  
glass packers

Now install the 'L' packer, as example 1, as you do this fit the reinforcing plate where the adjuster bolt comes into contact with the packer. Now, with the doors slightly open wind the adjuster bolt down to lift the door as required. The bolt is accessed at the top of the sashes with a 4mm allen key.

**\*WARNING\*** Incorrect operation will result in damage to the glass unit. The adjuster bolt must come into contact with the reinforcing plate and the glass must have enough clearance when the adjustment is being made. At no point should the glass touch the sash. If it becomes close simply restart the process by amending the packing and readjust.

Once you are happy with the door heights finish off by fitting the final packers as you normally would, please ensure all are siliconed into place.

## 7. Installing Wedge Gasket



The first rule of fitting wedge gasket is to remember that it should be tight. This is so that the glass is forced to the outer gasket to create a weathertight seal.

Start by cutting the wedge gasket so that it can be installed in 1 piece all the way around (not in 4 separate pieces). Whilst it may be easier in 4 you have the risk of draughts and shrinkage.



If you find the gasket is dry, and in winter it may become firmer, do NOT spray lubricant as this can react with certain types of glass coating. Instead simply get a bucket of hot soapy water and put the gasket in for a minute to soften and become more pliable.

Start by cutting the end of the gasket to an arrow head and start in the corner of the sash (PIC 1)



Insert between the bead and the glass, remember it is meant to be tight.. To help it may be advisable to use some sort of chock (either wood or glass packers – nothing that will break a unit). This can be used to compress the unit against the E gasket and make fitting the wedge gasket easier (PIC 2)

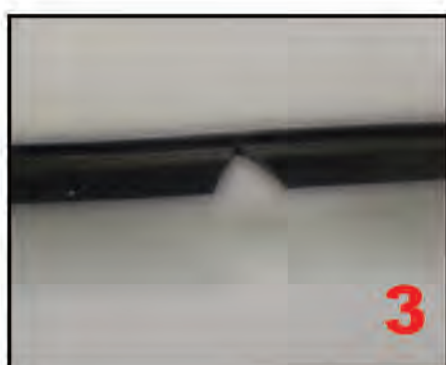

Do not force too hard as you may crack the unit. Move the spacer along as you push the gasket in.

When you come to the corner notch out a 'v' from the back of the gasket and form it around the corner (PIC 3)

It is important not to stretch the gasket as it will shrink over the coming weeks making the doors draughty, so feed the gasket back on itself as you push it in.

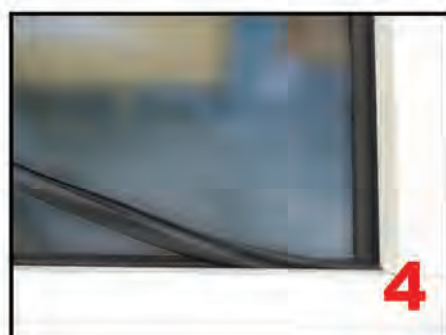

Once you have come to the end make the arrowhead on the gasket and fit so it meets and joins well (PIC 4)

Open Out - Detail 7

8. Gasket Detail

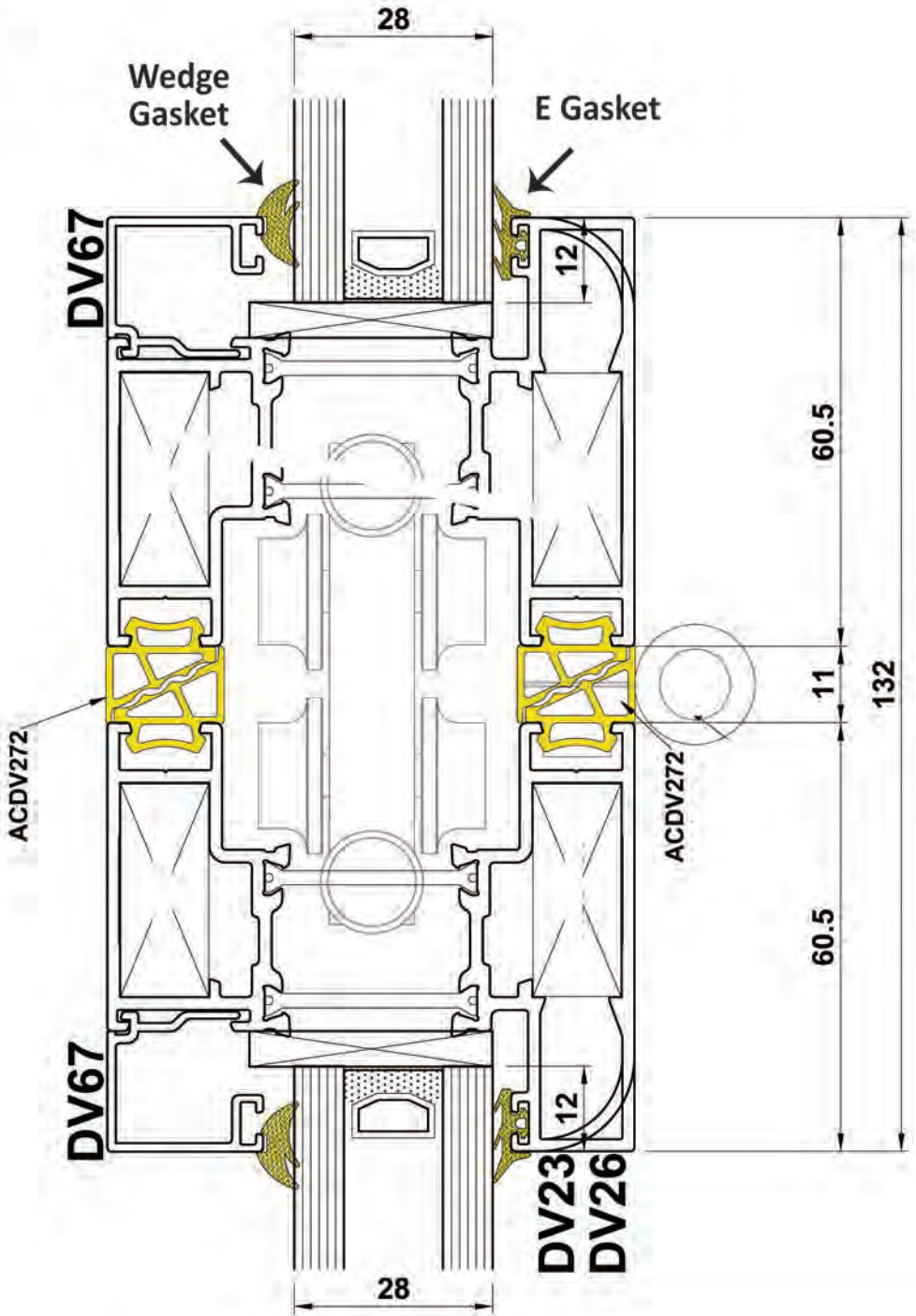
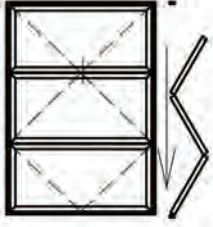

Do Not Scale From This Drawing

Open Out - Detail 5C

9(i). Low Threshold

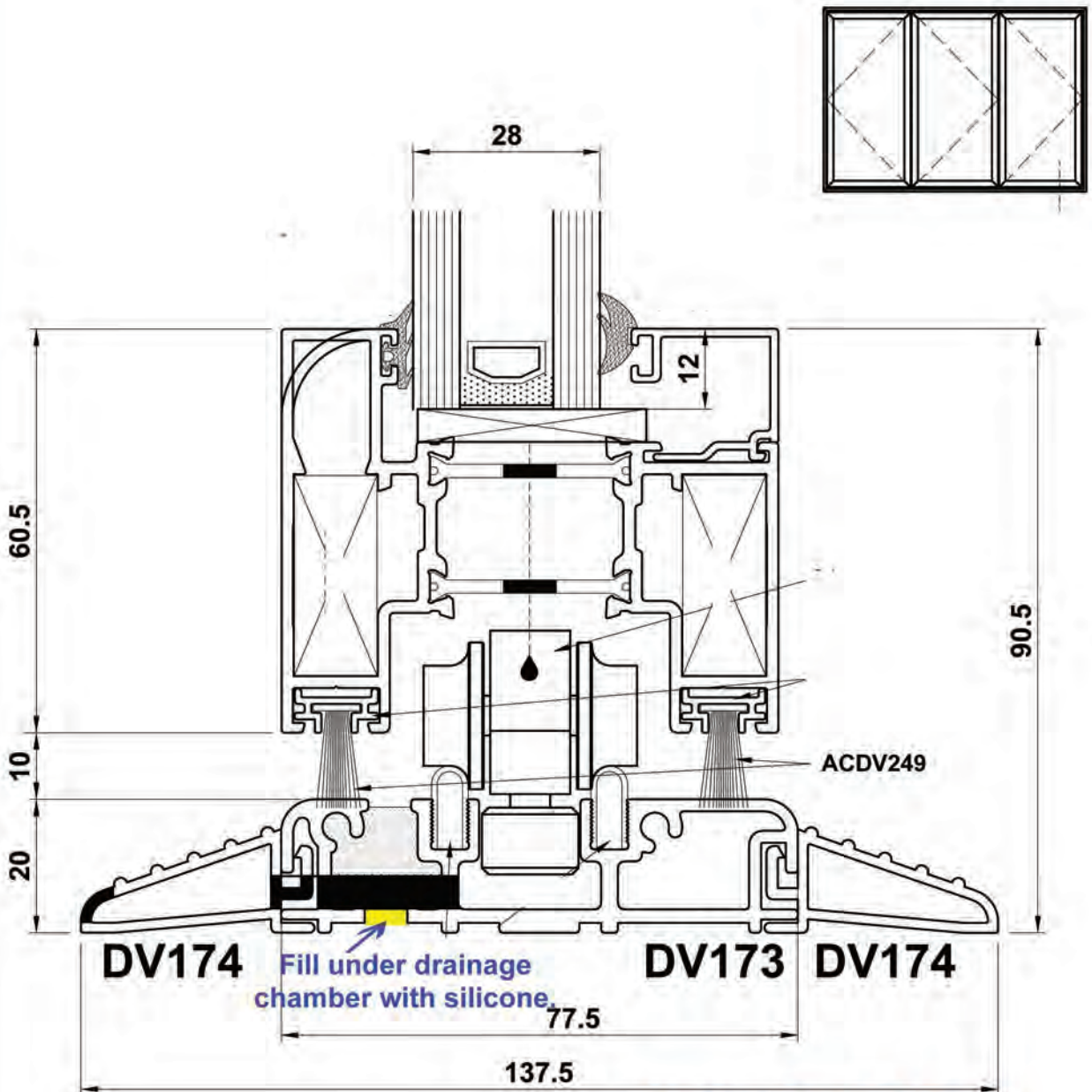

**Note: DV174 not compatible with a cill**

Do Not Scale From This Drawing

**Open Out - Detail 5A**

**9(ii) Standard Threshold**

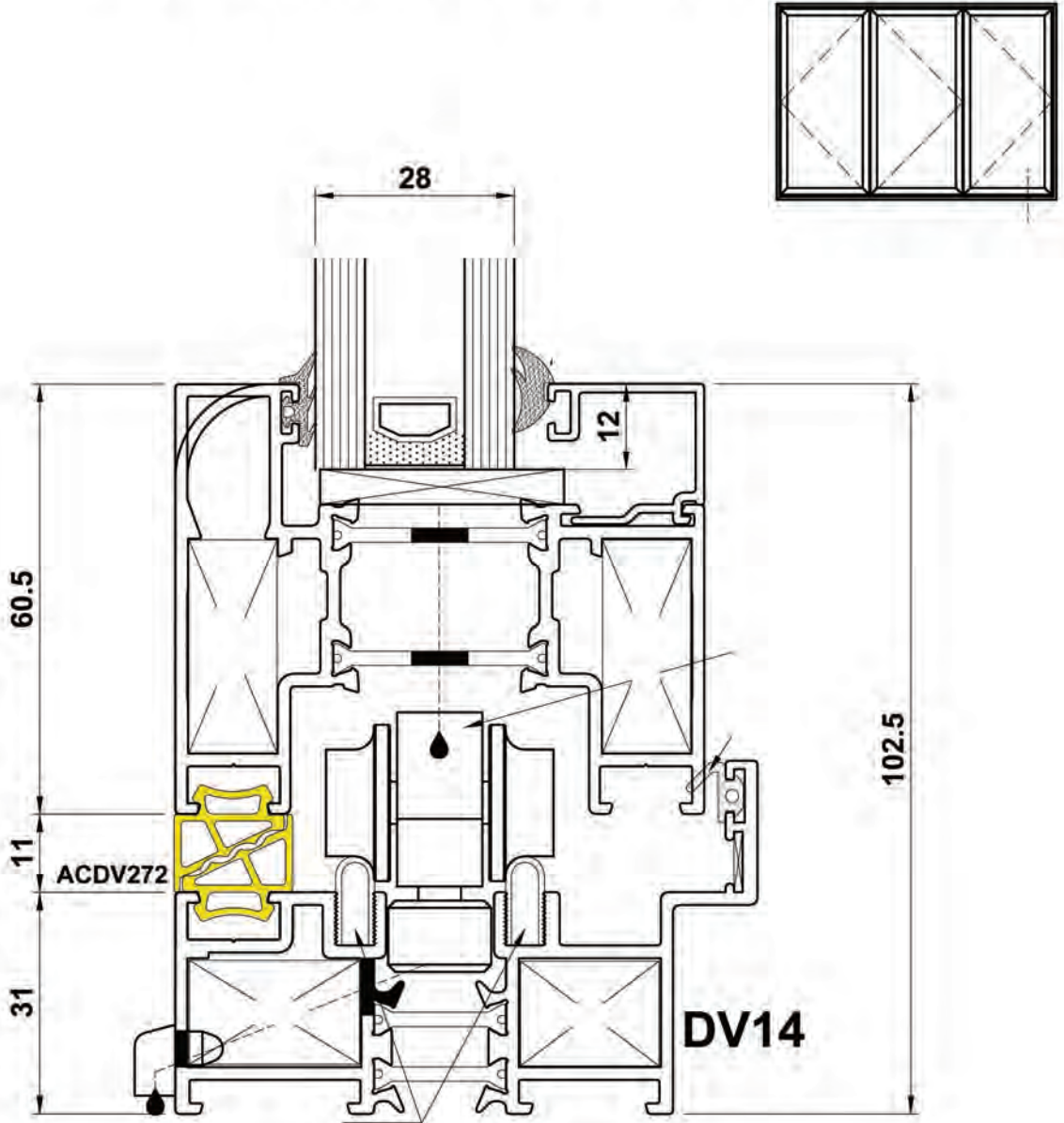

# 10. Add-ons & Trickle Vents

Trickle vent  
with Fly screen  
(External)

**DV515**

Trickle vent  
with vent control  
(Internal)

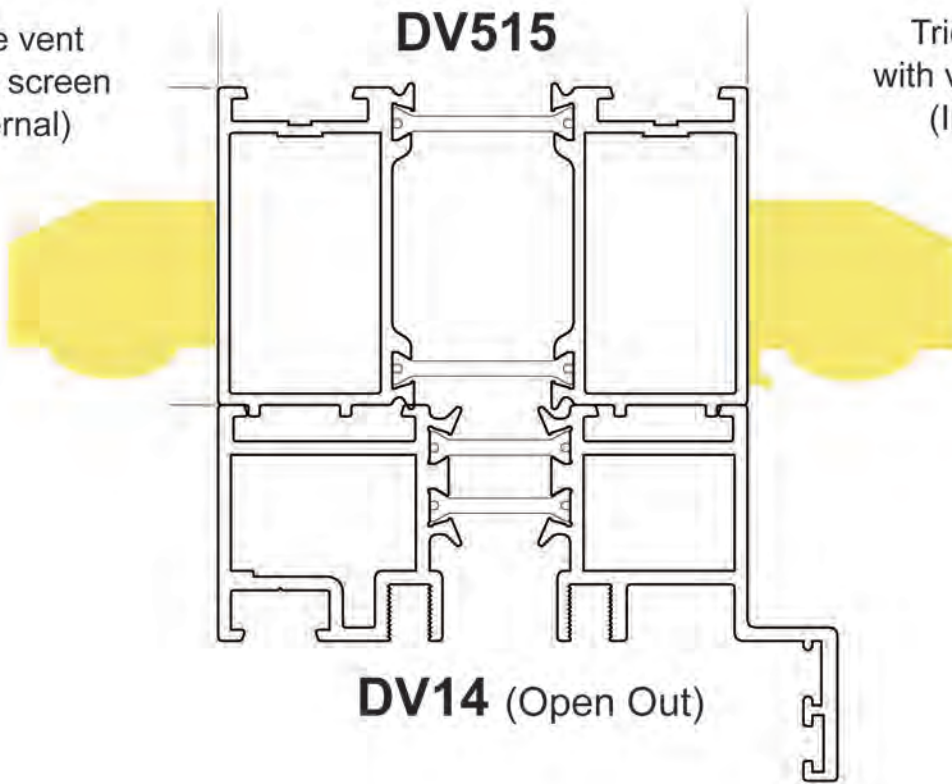

**AW42**

