

# Allstyle

Complete Aluminium  
Glazing System



## Aluminium Windows, Doors and Conservatories

Aluminium is a high strength and lightweight material that is used in every facet of the modern construction industry. From patio doors for homes to curtain walling in large commercial buildings - Allstyle manufacture products for all applications in an almost limitless range of styles and colours to suit any project.

The polyamide thermal break in our products achieves excellent thermal insulation and meets building regulations Part L with considerably reduced u-values.

Contact us today to discuss your next building or home improvement project.



Modern glazing solutions



Allstyle offers a complete aluminium glazing system for residential and commercial building projects

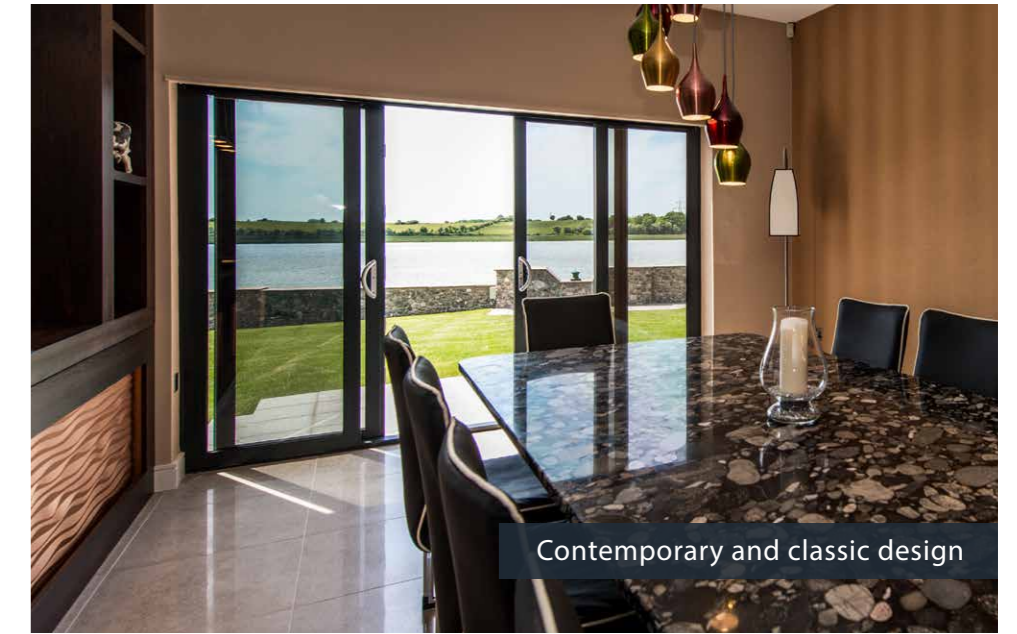

Contemporary and classic design



Light and space

The strength to weight ratio of aluminium allows us to construct frames with slim profiles that look neat and tidy in appearance but allow a lot of natural light into your property. We can also create larger frames in aluminium to reduce sightlines and help you make the most of the view out of your home.

Our range of aluminium bifolding doors allow you to seamlessly merge your home or conservatory with your garden.



## Bifolding Doors

Allstyle bifold doors are manufactured from slim thermally broken aluminium profiles which provide strength and security, allowing you to fold and slide the panels back to the left or right and open up an unobstructed wide opening to a patio, garden or outside space.

Folding doors for internal use can be specified with a low threshold or a rebated track so that two floor levels can remain constant. Our Visofold aluminium folding door has a 20mm low threshold which can be sunk into the floor.

- Reduced sightlines.
- Square or rounded edge profile options.
- Fabricated using mitred corners
- Marine grade powder coat available
- U Value: 1.8W/m<sup>2</sup>K
- Frame Width: 102.5mm
- Frame Depth: 70mm
- Glass: 28mm double/triple glazed
- Max o/a height (per sash): 2500mm
- Max o/a width (per sash): 1200mm
- Max Sash Weight: should not exceed 100kg
- Doc L 2010: Yes

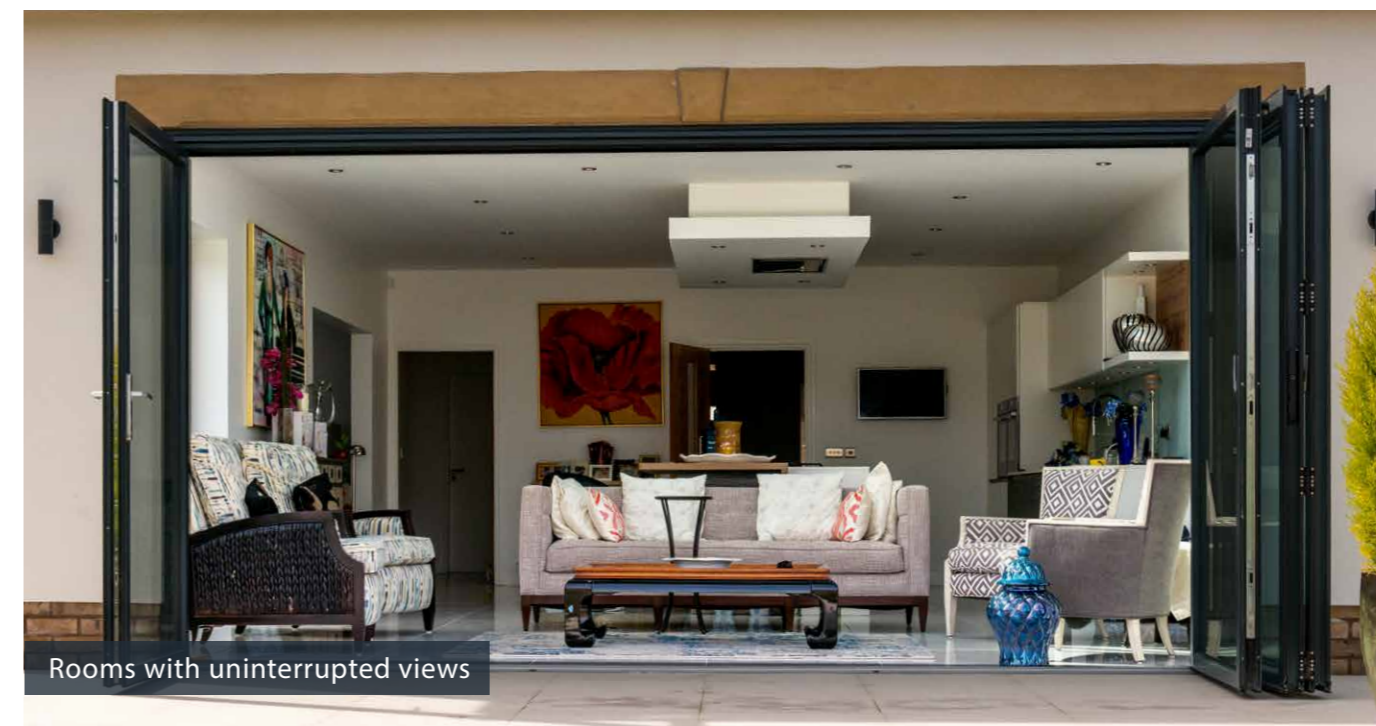

Rooms with uninterrupted views

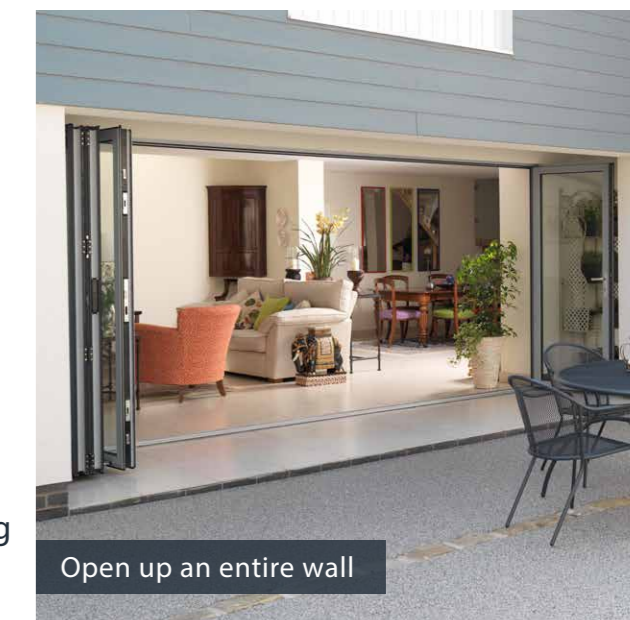

Open up an entire wall



Threshold and cill options

## Flexible Design

Allstyle bi-folding doors take up much less room than standard door, without the need to centre them on a supporting wall. Common door arrangements can be seen to the right of this page.

Doors can be up to 2.5 metres high and have a maximum panel width of 1200mm. Traffic doors can hinge like a conventional door or a French door.

These door arrangements are shown opening to the left but are also available opening to the right, and opening inwards or outwards.

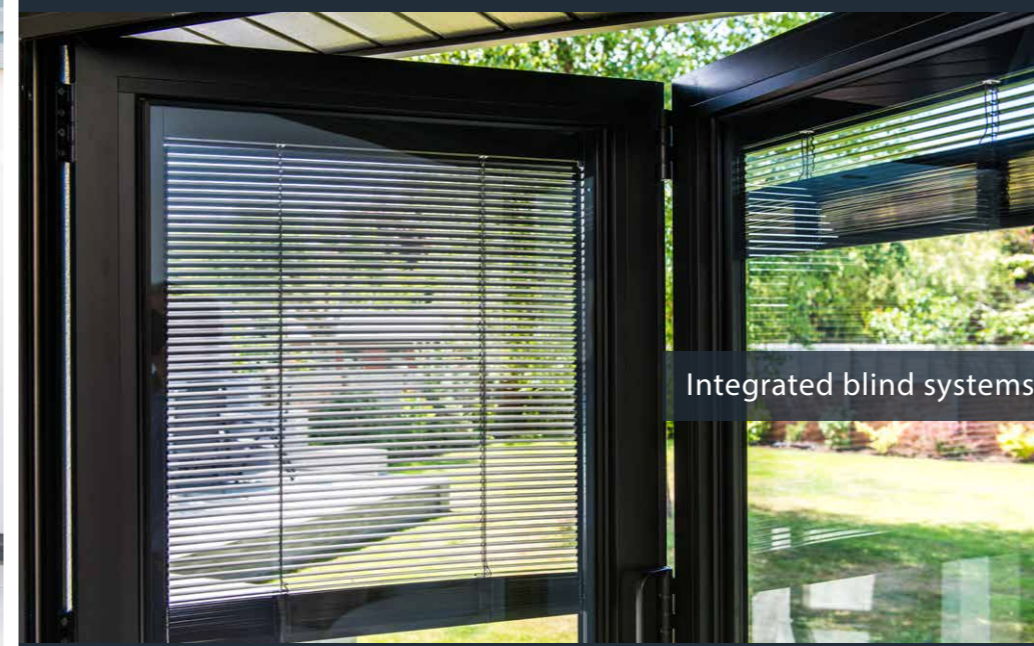
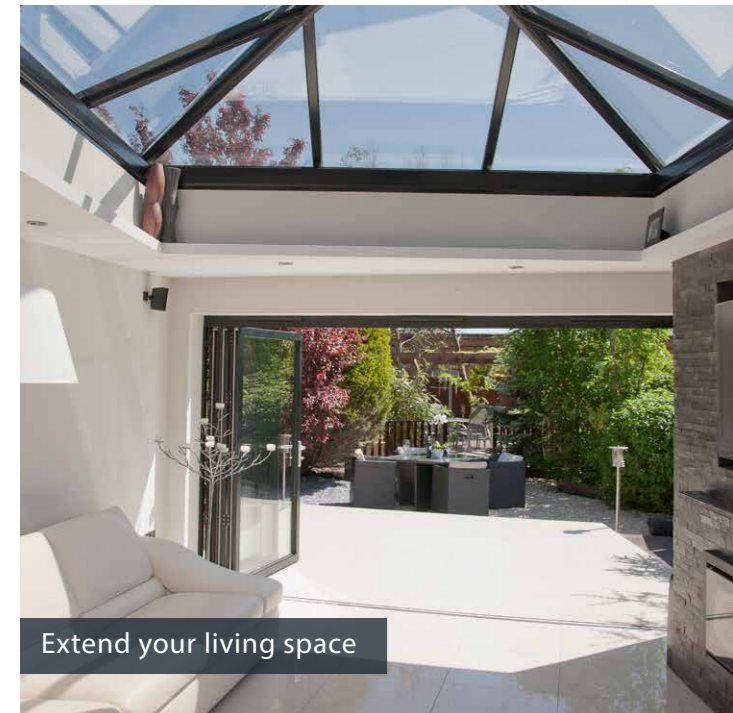
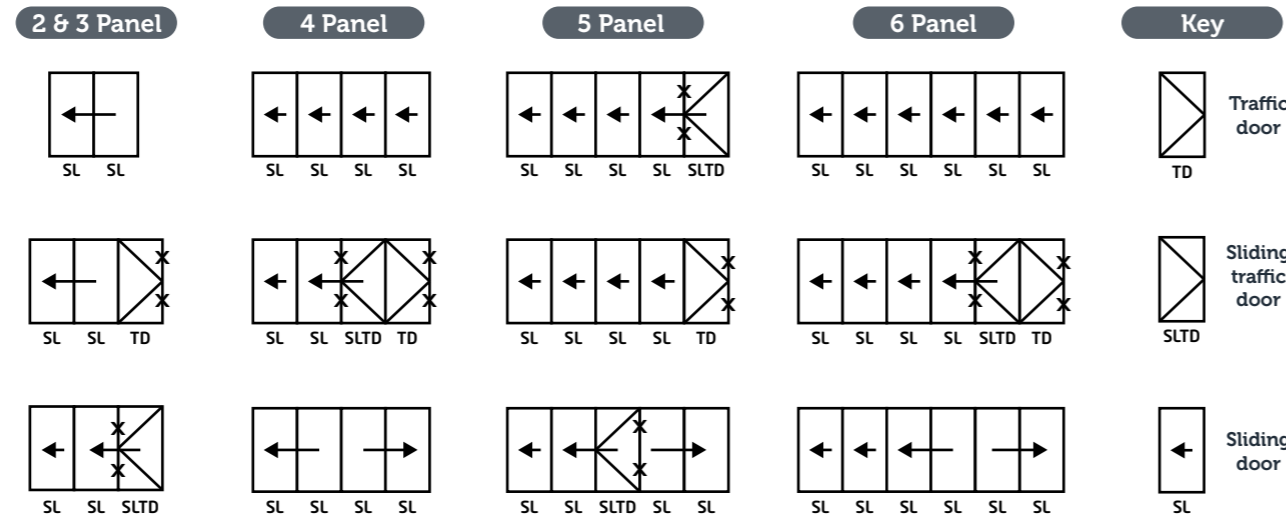

- Bifolds are available with threshold and cill options too, allowing you to seamlessly blend inside and out. Choose from a rebated (weathered) threshold or low thresher and cills. Bifolds run smoothly inside tracks.
- Stainless steel or matching coloured hardware like handles and hinges available. There is optional keyed locking on slave handle(s) to further secure and multi-point locking systems for ultimate security on bifolds.
- We are able to powder coat to any RAL colour in both single and dual colour, and can supply a matte finish. A marine grade powder coat is also available if required.
- Integrated blinds can be installed within our sealed glass units and are available in a range of colours to complement your windows, doors and decoration.

Blinds are operated by a cleverly-designed magnetic slider, placed on the right or left-hand edge of the glass. A narrow adhesive transparent profile ensures the linear movement of the slider. The blind is raised and lowered by moving the slider up or down and is tilted by slightly lifting or lowering the same slider.

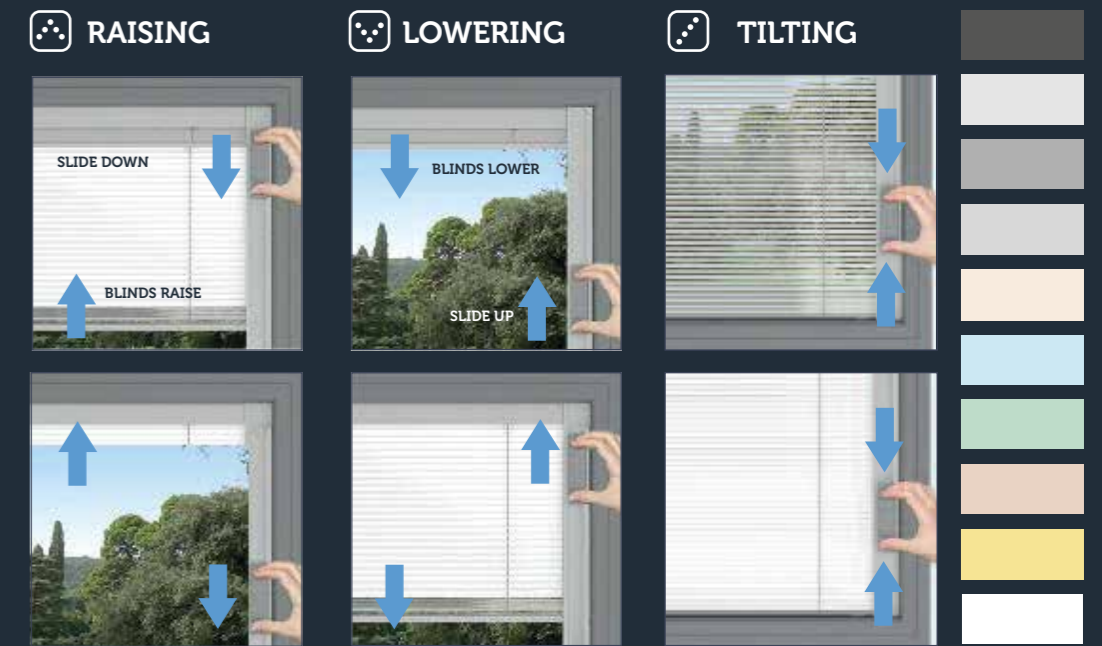

# Aluminium Window Systems

Aluminium is a smart choice for any renovation or homebuilding project. It combines strength and durability in a lightweight material and slim frames, offering clean designs that allow light to flood into your home.

Made to measure, our windows can be manufactured for a variety of glazing solutions including fixed windows, side hung, top hung, open out, sash windows, tilt and turns, angled windows and bay windows. They are all appropriate for both residential and commercial applications.



Our windows are fitted with multi-point steel locking mechanisms that exceed British Standards for security. Key locking handles are supplied on all opening lights.



Allstyle windows and doors are thermally efficient, contributing to a reduction in the cost of heating bills. Warmth and comfort are built in to our window systems.



We are able to manufacture our window products in any RAL colour and with a matte finish. We can provide dual colour RAL coating if you need different colours inside and outside too.



Our aluminium frames will never rot, rust, peel or flake, making them maintenance free. We offer our windows with a 10 year guarantee for your peace of mind - Allstyle windows are a sound investment.



We have a choice of masked trickle ventilation with an integrated head, ensuring that the stylish and slim look of aluminium windows will not be disrupted by visible night vent canopy hoods.

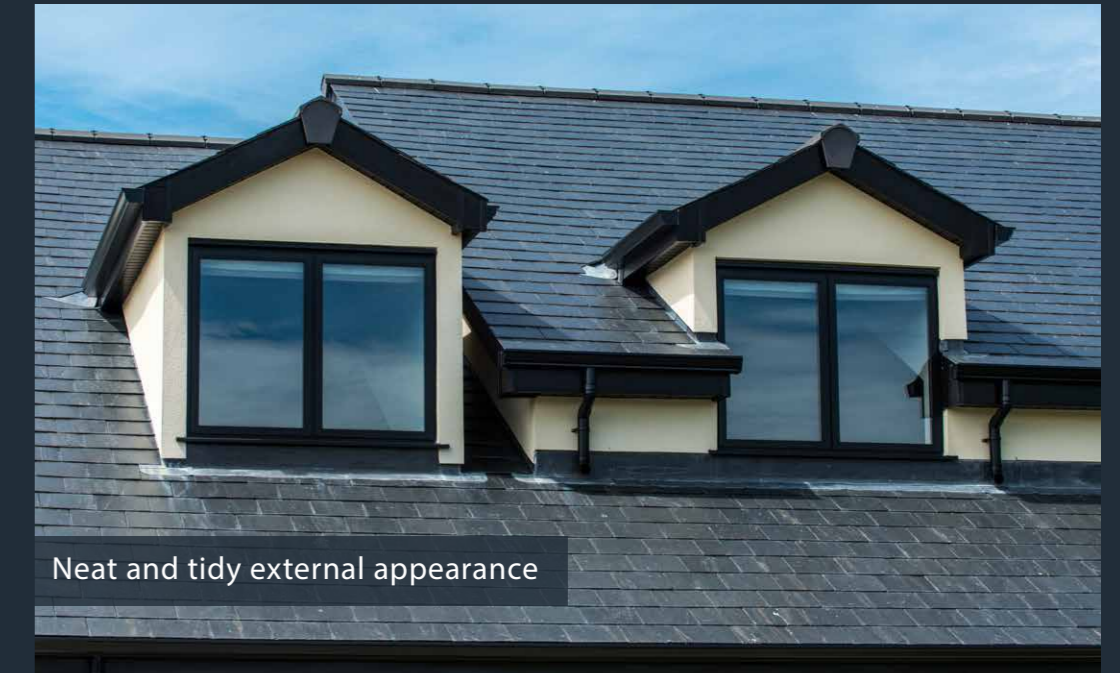
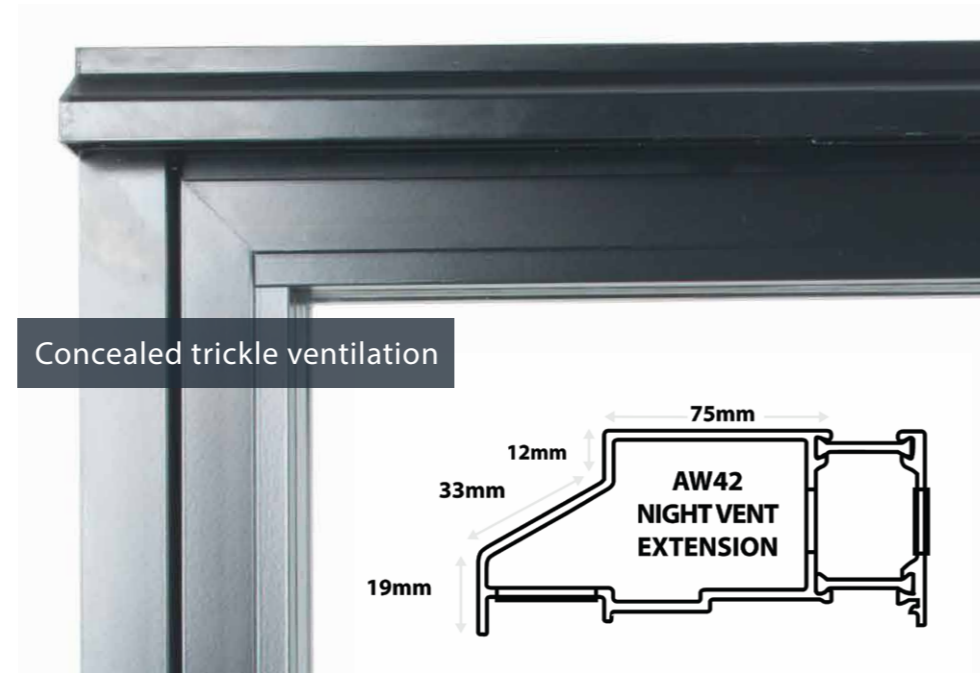

## Bespoke Solutions

As one of the UK's largest and most experienced manufacturers, the Allstyle team has a wide knowledge base and a vast combined experience in the design and production of a range of truly bespoke glazing solutions.

Contact us today for assistance with your next home improvement, renovation or building project.



## Tilt & Turn Windows

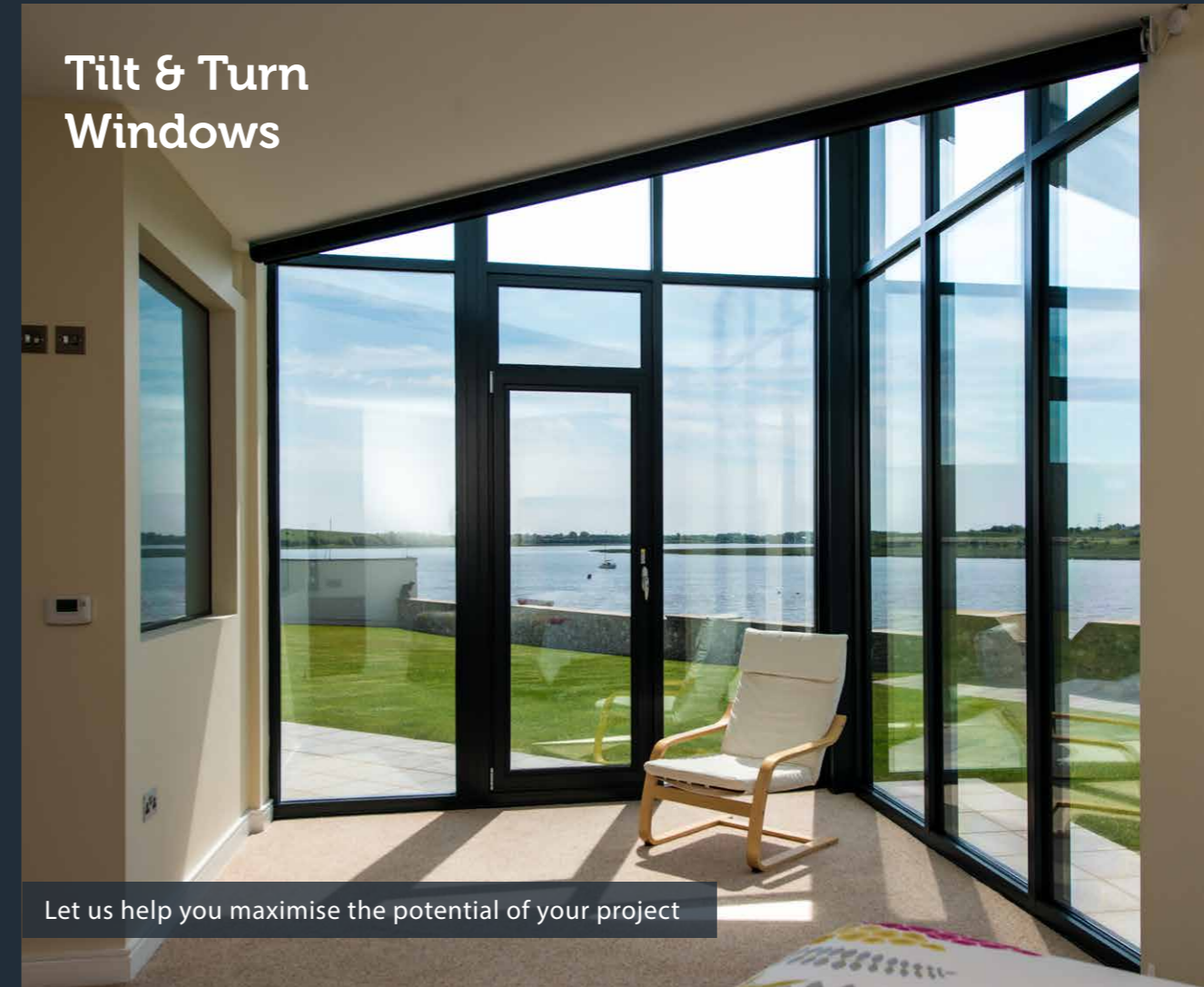

For those looking for a sleek design that can give both excellent ventilation and a much larger opening potential, the Allstyle Tilt and Turn is the way forward. Opening in, Tilt and Turn windows are perfect for a balconies and low level glazing where an open out window just won't do. Larger apertures are also possible with Tilt and Turn.

Allstyle Tilt and Turn windows are available with all of the same matching finishes and fixtures as our other window and door systems.

In the 'Tilt' position, the windows can open inwards from the bottom (as below) allowing you to open windows for ventilation while maintaining security.

The 'Turn' position allows the window to open fully inwards, in the normal way you would, from the side.

Flexibility is the key advantage of Tilt & Turn windows.





Completely redefine a room

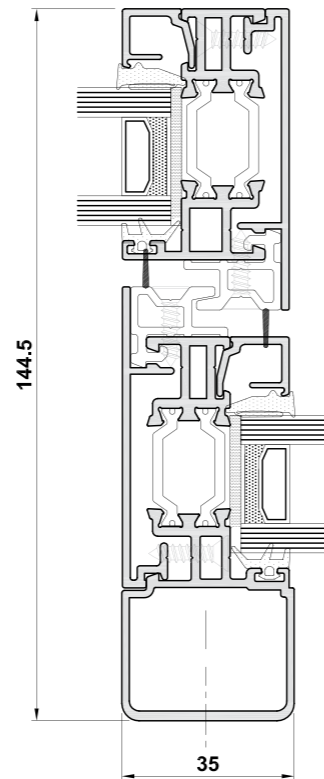

Slim 35mm Interlock

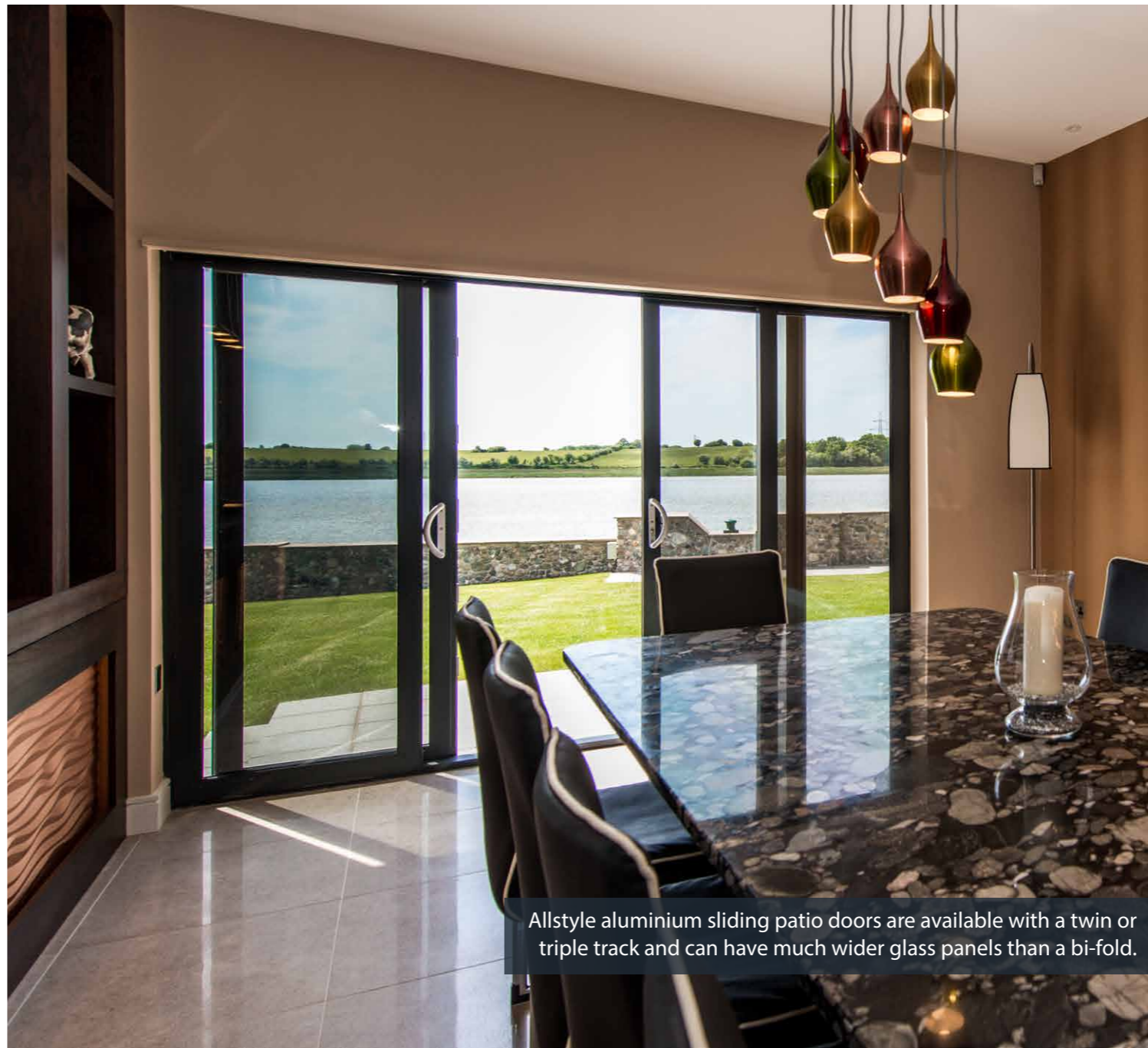

Allstyle aluminium sliding patio doors are available with a twin or triple track and can have much wider glass panels than a bi-fold.

### Key features of our sliding patio doors:

- Designed for use as fixed lights & horizontal sliding doors in domestic and commercial applications.
- Weight limit 200Kg. Height limit 2500mm (sash).
- Doc L 2010 compliant.
- u-Value: 1.6 W/m<sup>2</sup>K based on using a sealed unit with 1.0 W/m<sup>2</sup>K centre pane
- Polyamide thermal break allowing dual colour option.
- Glazing: 38mm double or triple glazed units
- Depth of Frame: 100mm
- Typical Sightlines: 117mm (OF) 83mm (Interlock)
- Available in a huge range of powder coated paint colours and finishes.
- **Our sliding patios are available with the Slim 35mm Interlock**

## Sliding Patio Doors

Allstyle manufacture aluminium sliding patio doors that will give you a room with a view. By using aluminium, our patio doors can span huge glazed areas with fewer sightlines - more glass and less frame allows more natural light to be pass through and allow you to make the most of a great view - they are perfect for balconies.

We construct our doors from profiles with a thermal break. Robust sections enable the creation of large passage-ways providing maximum natural light and panoramic views. Moveable panels that slide to the left or right sit within an outer frame. The system offers flexibility in terms of the possible combinations of folding elements and opening sashes.



Create large glazed openings with aluminium sliding patio doors

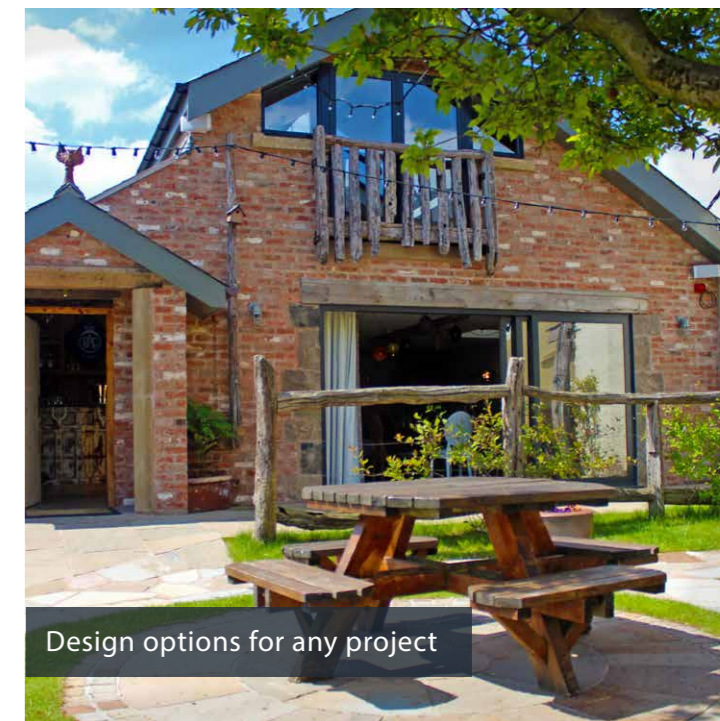

Design options for any project

## Lanterns & Rooflights

Whether you are replacing an existing roof or are in the process of building a new extension, a lantern roof from Allstyle is an ideal way to draw more natural light into your room.

Our lanterns offer exceptional benefits unmatched by any other roof on the market. The internal and external design compliments any home whilst flooding any room with maximum natural light.

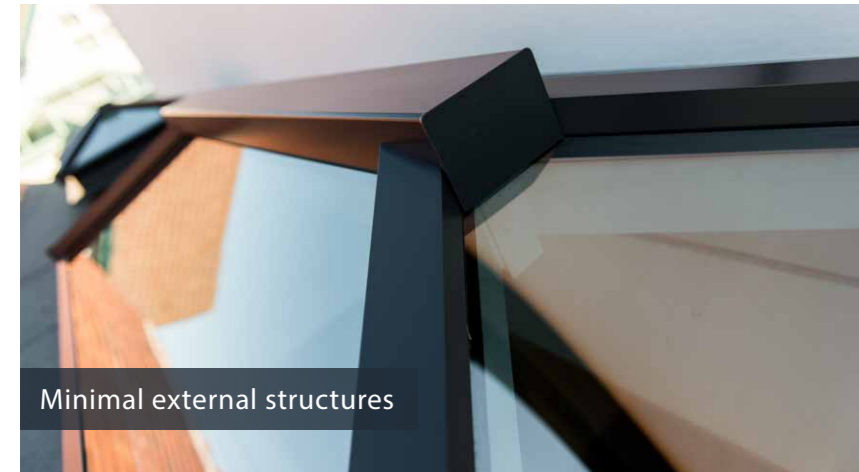

Minimal external structures

Ultra slim frames are achieved with the impressive strength to weight ratio of aluminium and ensure that sightlines are minimal. As our rooflights are fully aluminium, with no plastic caps, bosses or hoods, we can design roofs in any RAL colour to complement existing or additional home improvements made in aluminium.

The thermal insulation in an aluminium roof will ensure that your room is comfortable all year round. You will also reduce the risk of condensation and cloudiness.



Optimal views



Reduced sightlines



Full aluminium roofs



Ultimate Performance

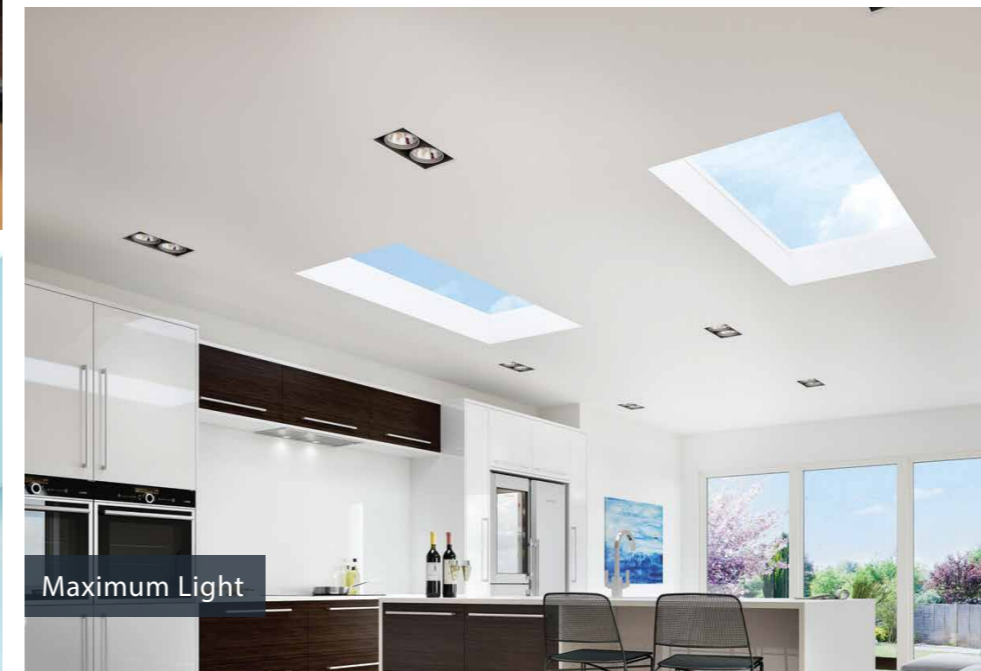

Maximum Light



Minimal sightlines

1. Unrivalled design aesthetics
2. Market leading thermal performance
3. Wide choice of colours: white, grey, black or dual colours - grey outside, white inside or black outside, white inside
4. Special RAL colours available
5. 10 year seal and easy clean coating warranty as standard
6. Low e insulated toughened double glazed as standard
7. Low maintenance, solar control glass options available
8. Insulated kerb upstand available

**OVERALL U VALUE (FRAME AND GLASS) 1.3 W/M<sup>2</sup>K**  
GLASS U VALUE 1.0 W/M<sup>2</sup>K



## Doors

We offer a range of high-security, robust doors to complement our window range, Anything from a functional rear door, French doors to open up a patio or balcony area, to a range of bespoke entrance doors complete with a choice of designer stainless steel handles and feature panels. The choices and colours are practically endless.

Our ranges of doors suitable for the architectural, commercial, public, new build and retail markets. The doors available are commercial hinged, commercial swing, patio, tilt and slide, slide folding, multi-track slide and automatic. Doors are designed for use as open out or open in, single or double doors, internally or externally beaded with sidelight options for domestic and/or commercial applications.

### 47mm or 70mm System Available:

- New adjustable hinges and lock keeps
- Single & double doors use multi-point locking mechanisms
- Double doors feature dual lock mechanisms enabling handles on both sashes
- Door sections & hinges are designed with added strength delivering robust performance
- Internally beaded for open in and open out doors
- Profiles are contemporarily styled with a modern, square-edge design
- Low thresholds comply with Document M building legislation
- Z/T sash sections allow for greater coverage and weather resistance



Create the architectural look and feel

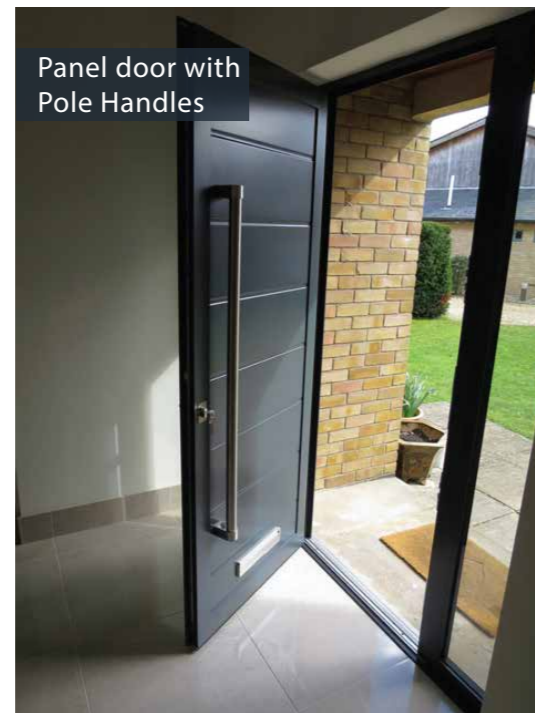

Panel door with Pole Handles



Alitherm Plus French Doors

## Conservatory Structures

The classic conservatory is a great way of creating extra living space without extending your home. They traditionally offer a great vantage point to enjoy a garden as they contain more glass than wall space.

Orangeries are also great for creating more living space. They are both traditional and contemporary - with brick pillars, they tend to have more wall than glass which makes them a more private room than a conservatory.

We can create a conservatory extension to fit most spaces. Create lots of natural light and airy spaces with an Allstyle conservatory. Available in a huge range of colours and designs, there is a suitable solution for all projects.

Our conservatory roof systems are an excellent standard and very well thought-out. By offering many options for tackling difficult sites, where box gutters and other features are required, we also consistently come up with innovative solutions to design problems.



Extend your living space

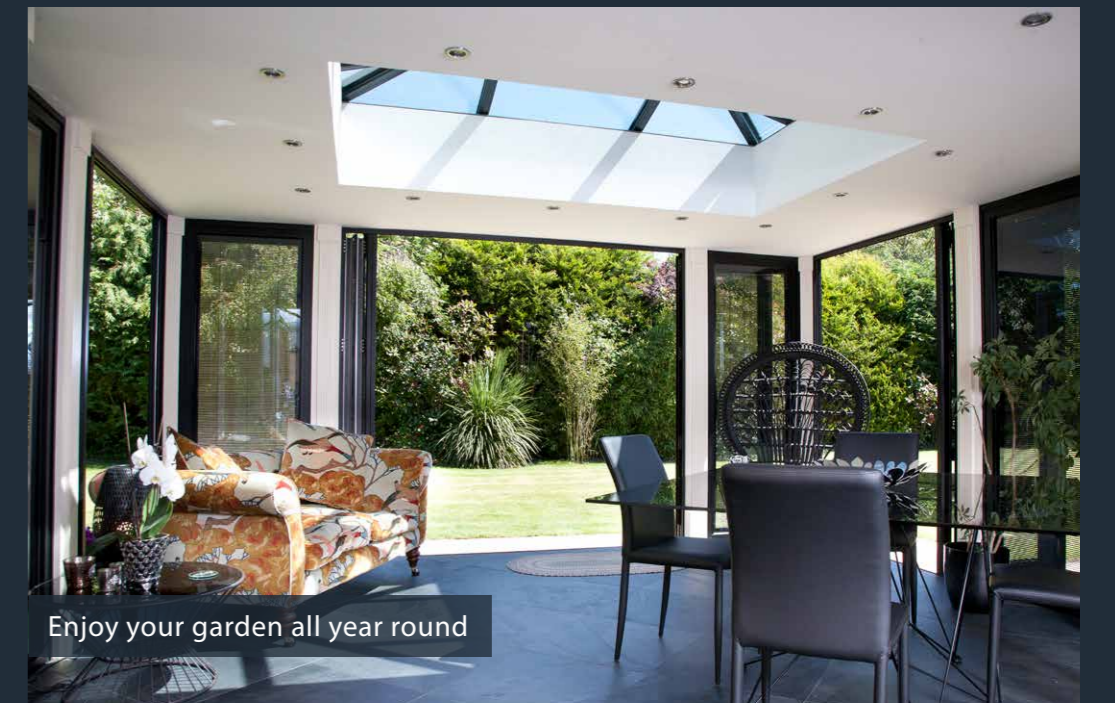

Enjoy your garden all year round

## Flush Look Aluminium Window System

We set out to create a window design which is seamless in appearance. Sleek sightlines and fluidity. Viewed externally the opening sash sits level with the outer frame in the closed position providing a sight line which is much more appealing to the eye than a traditionally made casement window.

Designed for top or side hung opening-out windows, this unique window is manufactured exclusively by Affordable Aluminium Systems Ltd. and can be complemented with a wide selection of hardware to achieve the look you desire.

### Key Features & Specifications:

- High-Security bi-directional pincer multi-point mechanism with key lockable night vent position.
- Fully compliant with Doc L of the Building Regulations (Conservation of Fuel and Power).
- Compliance with Document Q
- Window Energy Rating up to A
- Concealed Night Ventilation available where required
- Concealed mullions and Transoms with slim sash to sash sightlines of just 102mm
- The in-line flush look is a perfect match with our bifolding doors.

### Sash Sizes

Top Hung – max. sash size: 1400x1300mm (40kg)  
Friction Stays – (up to and including) 24"  
Side Hung – max. sash size: 700\*x1400mm (28kg)  
Friction Stays – (up to and including) 16"  
\*800mm with Fire Escape Hinges



View Outside



View Inside

### Section Detail

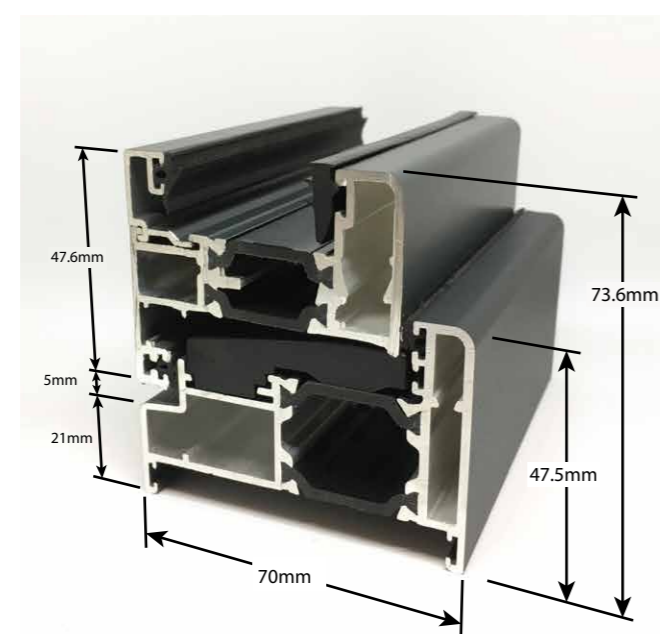

### Sash-to-Sash Sightlines

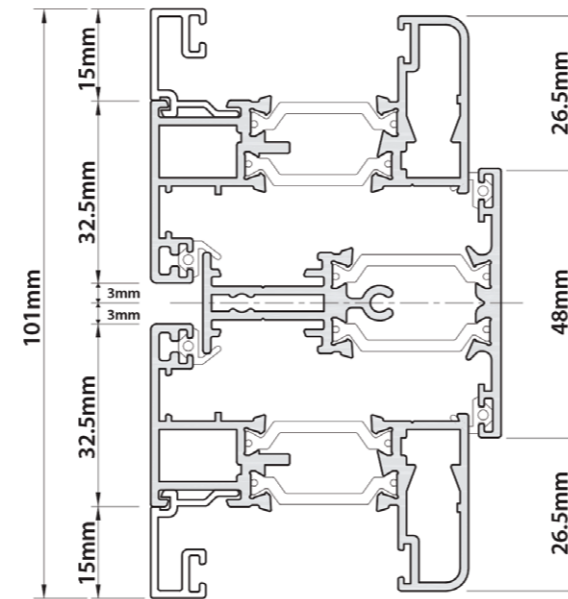

## Hardware & Furniture

### Tear Drop & Monkey-Tail Handles

With an elegant design that has been inspired by traditional 19th century ironmongery, Tear Drop or Monkey-Tail Handles are the perfect finishing touch for the Flush Look Aluminium Window.

- Strength tested to equivalent of a modern espagnolette window handle
- Strong espagnolette operator
- Manufactured from die-cast zinc with specially formulated finish
- Harder wearing finish than traditional wrought iron furniture
- Matching Tear Drop Dummy and Operating Stays, and Monkey Tail Dummy Stays also available
- Create a perfectly matching heritage window
- Key locking & Security enabled

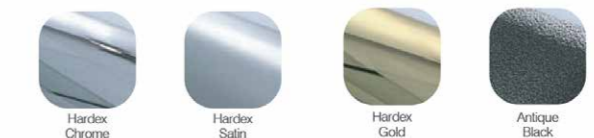

### Espagnolette Handle

- Die cast aluminium lever – The perfect balance of price and performance
- Solid zinc baseplate – Stability and security
- Heavy duty sprung latching block – Positive click on closing
- Long handle with 50mm window clearance – Greater leverage and easy to operate without catching a hand on the window
- Classic design with a contemporary twist – Create an elegant and stylish window
- Patented cover caps with colour coordinated finish – Perfectly matching components, even down to the smallest details.



Minimal Sightlines

For more information, contact:

The strength to weight ratio of aluminium allows us to construct frames with slim profiles that look neat and tidy in appearance but allow a lot of natural light into your property. We can also create larger frames in aluminium to reduce sightlines and help you make the most of your home.

Allstyle doors are manufactured from slim thermally broken aluminium profiles which provide strength and security, allowing you to fold and slide the panels back to left or right and open up an unobstructed wide opening to a patio or garden.

Folding doors can be specified with a rebated or low threshold so that two floor levels can remain constant.

Disclaimer: From time to time, dimensions, hardware and designs of our products will change to reflect product development. Accordingly, photographs, drawings, and product dimensions may not always be accurately represented on our website or in brochure material. In addition material colours on our website and brochures are representations only. Printing and computers only show an approximation. Customers should choose colours from actual samples. Before purchasing any product you should check with your installer as to the current design, dimension and exact colour of any product.